



**INSTITUTO DE CIENCIAS
DE LA CONSTRUCCIÓN
EDUARDO TORROJA**

C/ Serrano Galvache n. 4 28033 Madrid (Spain)
Tel.: (34) 91 302 04 40 Fax: (34) 91 302 07 00
direccion.ietcc@csic.es <https://dit.ietcc.csic.es>



European Technical Assessment

**ETA 20/0046
of 17/04/2020**

English translation prepared by IETcc. Original version in Spanish language

General Part

Technical Assessment Body issuing the ETA designated according to Art. 29 of Regulation (EU) 305/2011:

Instituto de Ciencias de la Construcción Eduardo Torroja (IETcc)

Trade name of the construction product:

Screw anchor THE

Product family to which the construction product belongs:

Screw anchor of sizes 6, 8, 10, 12, 14 and 18 for use in concrete.

Manufacturer:

Index - Técnicas Expansivas S.L.
Segador 13
26006 Logroño (La Rioja) Spain.
website: www.indexfix.com

Manufacturing plant:

Index plant 2

This European Technical Assessment contains:

14 pages including 3 annexes which form an integral part of this assessment.

This European Technical Assessment is issued in accordance with regulation (EU) No 305/2011, on the basis of:

European Technical Assessment EAD 330232-00-0601 "Mechanical Fasteners for use in concrete", ed. October 2016

English translation prepared by IETcc

This European Technical Assessment is issued by the Technical Assessment Body in its official language. Translations of this European Technical Assessment in other languages shall fully correspond to the original issued document and should be identified as such.

This European Technical Assessment may be withdrawn by the issuing Technical Assessment Body, in particular pursuant to information by the Commission according to article 25 (3) of Regulation (EU) No 305/2011.

SPECIFIC PART

1. Technical description of the product

The Index screw anchor THE is a fastener made of carbon steel of sizes 6, 8, 10, 12, 14 and 18. The fastener is installed into a predrilled cylindrical hole. The special thread of the fastener cuts an internal thread into the concrete member while setting. The anchorage is characterised by mechanical interlock between fastener and concrete.

Product and installation descriptions are given in annex A.

2. Specification of the intended use in accordance with the applicable European Assessment Document.

The performances given in section 3 are only valid if the anchor is used in compliance with the specifications and conditions given in annex B.

The verifications and assessment methods on which this European Technical Assessment is based lead to the assumption of a working life of the anchor of at least 50 years. The indications given on the working life cannot be interpreted as a guarantee given by the producer, but are to be regarded only as a mean to choosing the right products in relation to the expected economically reasonable working life of the works.

3. Performance of the product and references to the methods used for its assessment

3.1 Mechanical resistance and stability (BWR 1)

Essential characteristic	Performance
Characteristic resistance under static or quasi static loading	See annexes C3 and C4
Displacements under tension and shear loads	See annex C5

3.2 Safety in case of fire (BWR 2)

Essential characteristic	Performance
Reaction to fire	Anchorage satisfy requirements for class A1
Resistance to fire	See annexes C6 and C7

4. Assessment and Verification of Constancy of Performances (hereinafter AVCP) system applied, with reference to its legal base

The applicable European legal act for the system of Assessment and Verification of Constancy of Performances (see annex V to Regulation (EU) No 305/2011) is 96/582/EC.

The system to be applied is 1.

English translation prepared by IETcc

5. Technical details necessary for the implementation of the AVCP system, as provided for in the applicable European Assessment Document.

The technical details necessary for the implementation of the AVCP system are laid down in the quality plan deposited at Instituto de Ciencias de la Construcción Eduardo Torroja.



Instituto de Ciencias de la Construcción Eduardo Torroja
CONSEJO SUPERIOR DE INVESTIGACIONES CIENTÍFICAS

C/ Serrano Galvache n.º 4. 28033 Madrid.
Tel: (+34) 91 302 04 40 Fax. (+34) 91 302 07 00
<https://dit.ietcc.csic.es>



On behalf of the Instituto de Ciencias de la Construcción Eduardo Torroja
Madrid, 17th of April 2020



Director

English translation prepared by IETcc

Product types

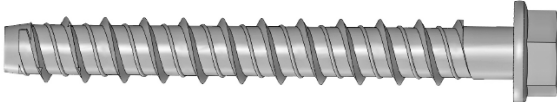
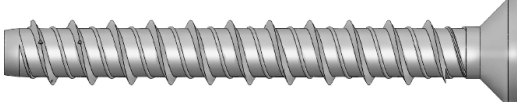
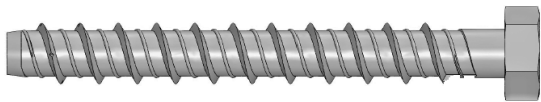
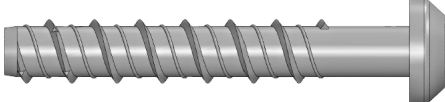
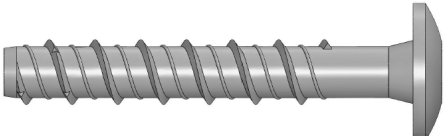
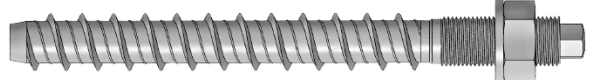
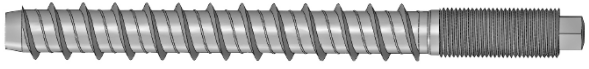
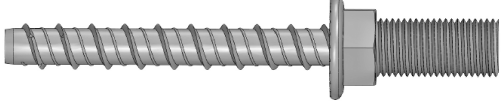
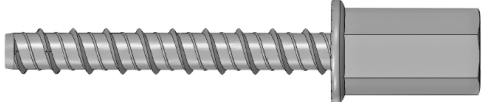
Picture	Sizes	Code	Coating
	Hexagonal head with flange. Sizes: 6, 8, 10, 12, 14 and 18	THE	Atlantis
		TFE	Zinc plated
		TNE	Zinc nickel
		TKE	Zinc flake
		TGE	Mech. galv.
	Countersunk, Six lob recess Sizes: 6, 8 and 10	THA	Atlantis
		TFA	Zinc plated
		TNA	Zinc nickel
		TKA	Zinc flake
		TGA	Mech. galv.
	Hexagonal head. Sizes: 6, 8, 10, 12, 14 and 18	THN	Atlantis
		TFN	Zinc plated
		TNN	Zinc nickel
		TKN	Zinc flake
		TGN	Mech. galv.
	Pan head. Six lob recess Sizes: 6 and 8	THT	Atlantis
		TFT	Zinc plated
		TNT	Zinc nickel
		TKT	Zinc flake
		TGT	Mech. galv.
	Truss head. Six lob recess. Size: 6	THP	Atlantis
		TFP	Zinc plated
		TNP	Zinc nickel
		TKP	Zinc flake
		TGP	Mech. galv.
	Stud head with DIN 934 class 6 nut and DIN 125 washer Sizes: 6, 8 and 10	TFW	Zinc plated
		TNW	Zinc nickel
		TKW	Zinc flake
	Stud head Sizes: 6, 8 and 10	TFS	Zinc plated
		TNS	Zinc nickel
		TKS	Zinc flake
	Male thread Size: 6, external thread M8x16; M10x21	TFM	Zinc plated
		TNM	Zinc nickel
		TKM	Zinc flake
	Female thread (rod hanger) Size: 6, internal thread M8 / M10	TFF	Zinc plated
		TNF	Zinc nickel
		TKF	Zinc flake

THE screw anchor	Annex A1
Product description	
Screw types	

English translation prepared by IETcc

Installed condition

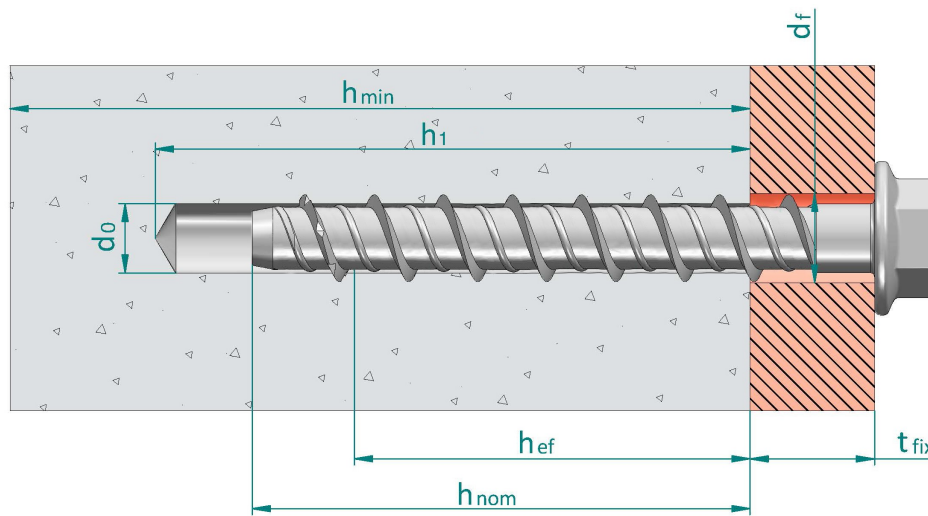

- d_0 : Nominal diameter of drill bit
- d_f : Fixture clearance hole diameter
- h_{ef} : Effective anchorage depth
- h_1 : Depth of drilled hole
- h_{nom} : Overall fastener embedment depth in the concrete
- h_{min} : Minimum thickness of concrete member
- t_{fix} : Fixture thickness

Identification on head of fastener: company logo + size x length

For heads where no space enough space is available, length mark can be replaced by the following letter codes.

Letter on head	Length [mm]
A	35 ÷ 50
B	51 ÷ 62
C	63 ÷ 75
D	76 ÷ 88
E	89 ÷ 101
F	102 ÷ 113
G	114 ÷ 126
H	127 ÷ 139
I	140 ÷ 153

Table A1: Materials

Item	Designation	Material for screw anchor
1	Fastener body	Carbon steel, galvanized $\geq 5 \mu\text{m}$ ISO 4042 Zn5/An/T0 Carbon steel, zinc nickel $\geq 8 \mu\text{m}$ ISO 4042, ZnNi8/An/T2 Carbon steel, zinc flake $\geq 6 \mu\text{m}$ ISO 10683 Carbon steel, mechanical galvanizing $\geq 40 \mu\text{m}$ EN ISO 12683 Zn 40 M(Fe) Carbon steel, Atlantis coating

THE screw anchor

Product description

Installed condition and materials

Annex A2

Specifications of intended use

Anchorage subjected to:

- Static or quasi static loads: all sizes and embedment depths.
- Resistance to fire exposure up to 120 minutes: all sizes and embedment depths.

Base materials:

- Reinforced or unreinforced normal weight concrete according to EN 206:2013.
- Strength classes C20/25 to C50/60 according to EN 206:2013.
- Cracked or uncracked concrete.

Use conditions (environmental conditions):

- Anchorages subjected to dry internal conditions.

Design:

- Anchorages are designed under the responsibility of an engineer experienced in anchorages and concrete work.
- Verifiable calculation rules and drawings are prepared taking into account of the loads to be anchored. The position of the fastener is indicated on the design drawings (e.g. position of the fastener relative to reinforcement or to supports, etc.).
- Anchorages under static or quasi-static actions are designed for design method A in accordance with EN 1992-4: 2018.
- Anchorages under fire exposure are designed in accordance with EN 1992-4: 2018. It must be ensured that local spalling of the concrete cover does not occur.

Installation:

- Hole drilling by rotary plus hammer mode: all sizes and embedment depths.
- Fastener installation carried out by appropriately qualified personal and under the supervision of the person responsible for technical matters of the site.
- In case of aborted hole: new drilling at a minimum distance away of twice the depth of aborted hole or smaller distance if the aborted hole is filled with high strength mortar and if under shear or oblique tension load it is not the direction of the load application.
- After installation further turning of the anchor must not be possible.
- The head of the fastener must be supported on the fixture and is not damaged.

THE screw anchor	Annex B1
Intended use	
Specifications	

English translation prepared by IETcc

Table C1: Installation parameters

Installation parameters			Performances						
			6		8		10		
h_{nom}	Nominal embedment depth:	[mm]	35	55	50	65	55	75	85
h_{ef}	Effective anchorage depth:	[mm]	26,0	43,0	37,5	50,5	41,5	58,5	67,0
d_0	Nominal diameter of drill bit:	[mm]	6		8		10		
d_f	Clearance hole diameter \leq	[mm]	9		12		14		
T_{inst}	Nominal installation torque:	[Nm]	10		20		30		
h_1	Depth of drilled hole \geq	[mm]	45	65	60	75	65	85	95
h_{min}	Minimum thickness of concrete member:	[mm]	100	100	100	100	100	120	135
L_{min}	Total length of the fastener:	[mm]	40	60	55	70	60	80	90
L_{max}		[mm]	150	150	150	150	150	150	150
t_{fix}	Thickness of fixture ¹⁾ :	[mm]	L-35	L-55	L-50	L-65	L-55	L-75	L-85
SW	Socket size	THE, TFE	10		13		15		
		TFF, TFM	13		--		--		
		TFS	5		7		8		
TX	Six lob recess	THA	30		45		50		
		THP	40		45		--		
		THT	30		--		--		
d_k	Diameter of countersunk head:	[mm]	12,4		18		21		
s_{min}	Minimum allowable spacing:	[mm]	35		35		50		
c_{min}	Minimum allowable distance:	[mm]	35		35		40		
Setting tool			Bosch GDS 18E, 500 W. $T_{impact,max}$ 160 Nm, or equivalent						

¹⁾ L = total fastener length

Installation parameters			Performances					
			12		14		18	
h_{nom}	Nominal embedment depth:	[mm]	75	105	75	115	90	140
h_{ef}	Effective anchorage depth:	[mm]	58,0	83,5	58,0	92,0	69,5	112,0
d_0	Nominal diameter of drill bit:	[mm]	12		14		18	
d_f	Clearance hole diameter \leq	[mm]	16		18		22	
T_{inst}	Nominal installation torque:	[Nm]	50		70		90	
h_1	Depth of drilled hole \geq	[mm]	90	120	90	130	110	160
h_{min}	Minimum thickness of concrete member:	[mm]	120	170	120	185	140	225
L_{min}	Total length of the fastener:	[mm]	80	110	80	120	95	145
L_{max}		[mm]	300	300	300	300	300	300
t_{fix}	Thickness of fixture ¹⁾ :	[mm]	L-75	L-105	L-75	L-115	L-90	L-140
SW	Socket size: THE, TFE	[mm]	18		21		24	
s_{min}	Minimum allowable spacing:	[mm]	75		80		90	
c_{min}	Minimum allowable distance:	[mm]	45		50		55	
Setting tool			Bosch GDS 18E, 500 W. $T_{impact,max}$ 160 Nm, or equivalent					

¹⁾ L = total fastener length

THE screw anchor	Annex C1
Performances	
Installation parameters	

Installation procedure

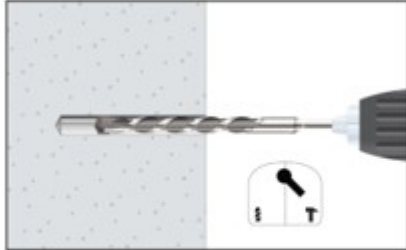

1. DRILL

Drill a hole into the base material of the correct diameter and depth using a carbide drill bit in rotary plus hammer mode.



2. BLOW AND CLEAN

Remove dust and debris from hole using a hand pump, compressed air or a vacuum to remove loose particles left from drilling.

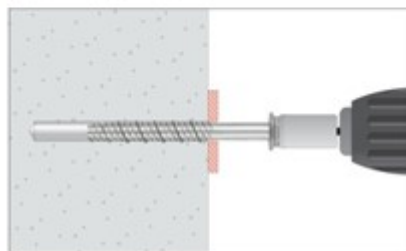

3. INSTALL

Select a powered impact wrench or a torque wrench that does not exceed the maximum torque $T_{\text{impact,max}}$ or $T_{\text{inst,max}}$ respectively. Attach an appropriate sized hex socket or six lob bit to the wrench. Mount the screw anchor head in the socket / bit.

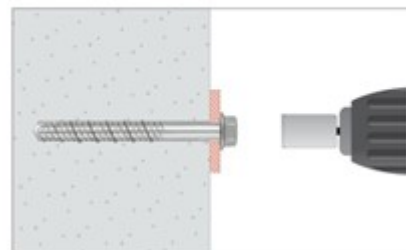

4. APPLY TORQUE

Drive the anchor with an impact driver or a torque wrench through the fixture and into the hole until the anchor head comes in contact with the fixture. The anchor must be snug after installation. Do not spin the socket off the anchor to disengage.

THE screw anchor

Performances

Installation procedure

Annex C2

Table C2: Characteristic values to tension loads of design method A according to EN1992-4

Characteristic values of resistance to tension loads according to design method A			Performances							
			6		8		10			
h_{nom}	Nominal embedment depth:	[mm]	35	55	50	65	55	75	85	
Tension loads: steel failure										
$N_{Rk,s}$	Characteristic resistance:	[kN]	25,12		39,14		54,81			
γ_{Ms}	Partial safety factor ¹⁾ :	[-]	1,4							
Tension loads: pull-out failure in concrete										
$N_{Rk,p}$	Characteristic resistance in C20/25 uncracked concrete:	[kN]	5	2)						
$N_{Rk,p}$	Characteristic resistance in C20/25 cracked concrete:	[kN]	2)							
ψ_c	Increasing factor for concrete	C30/37	[-]	1,16	1,22	1,21	1,22	1,22	1,17	1,22
		C40/45	[-]	1,28	1,41	1,39	1,41	1,41	1,30	1,41
		C50/60	[-]	1,39	1,58	1,54	1,58	1,58	1,42	1,58
Tension loads: concrete cone and splitting failure										
h_{ef}	Effective anchorage depth:	[mm]	26,0	43,0	37,5	50,5	41,5	58,5	67,0	
$k_{ucr,N}$	Factor for uncracked concrete:	[-]	11,0							
$k_{cr,N}$	Factor for cracked concrete:	[-]	7,7							
$s_{cr,N}$	Concrete Spacing:	[mm]	3 x h_{ef}							
$c_{cr,N}$	cone failure Edge distance	[mm]	1,5 x h_{ef}							
$s_{cr,sp}$	Spitting Spacing:	[mm]	90	170	130	200	140	190	210	
$c_{cr,sp}$	failure Edge distance	[mm]	45	85	65	100	70	95	105	
γ_{inst}	Robustness:	[-]	1,2	1,0	1,2	1,0	1,0	1,0	10	

¹⁾ In absence of other national regulations

²⁾ Pull out failure is not decisive

Characteristic values of resistance to tension loads according to design method A			Performances						
			12		14		18		
h_{nom}	Nominal embedment depth:	[mm]	75	105	75	115	90	140	
Tension loads: steel failure									
$N_{Rk,s}$	Characteristic resistance:	[kN]	74,48		105,45		161,56		
γ_{Ms}	Partial safety factor ¹⁾ :	[-]	1,4						
Tension loads: pull-out failure in concrete									
$N_{Rk,p}$	Characteristic resistance in C20/25 uncracked concrete:	[kN]	2)						
$N_{Rk,p}$	Characteristic resistance in C20/25 cracked concrete:	[kN]	2)						
ψ_c	Increasing factor for concrete	C30/37	[-]	1,16	1,22	1,21	1,20	1,22	1,17
		C40/45	[-]	1,29	1,41	1,39	1,37	1,40	1,32
		C50/60	[-]	1,40	1,58	1,55	1,51	1,57	1,42
Tension loads: concrete cone and splitting failure									
h_{ef}	Effective anchorage depth:	[mm]	58,0	83,5	58,0	92,0	69,5	112,0	
$k_{ucr,N}$	Factor for uncracked concrete:	[-]	11,0						
$k_{cr,N}$	Factor for cracked concrete:	[-]	7,7						
$s_{cr,N}$	Concrete Spacing:	[mm]	3 x h_{ef}						
$c_{cr,N}$	cone failure Edge distance	[mm]	1,5 x h_{ef}						
$s_{cr,sp}$	Spitting spacing:	[mm]	190	220	190	230	230	350	
$c_{cr,sp}$	failure Edge distance	[mm]	95	110	95	115	115	175	
γ_{inst}	Robustness:	[-]	1,0						

¹⁾ In absence of other national regulations

²⁾ Pull out failure is not decisive

THE screw anchor

Performances

Characteristic values for tension loads

Annex C3

Table C3: Characteristic values to shear loads of design method A according to EN 1992-4

Characteristic values of resistance to shear loads according to design method A		Performances						
		6		8		10		
h_{nom}	Nominal embedment depth: [mm]	35	55	50	65	55	75	85
Shear loads: steel failure without lever arm								
$V_{Rk,s}$	Characteristic resistance: [kN]	12,53		19,57		27,40		
k_7	Ductility factor: [--]	0,8						
γ_{Ms}	Partial safety factor ¹⁾ : [--]	1,5						
Shear loads: steel failure with lever arm								
$M^0_{Rk,s}$	Characteristic bending moment: [Nm]	21,6		44,6		78,3		
γ_{Ms}	Partial safety factor ¹⁾ : [-]	1,5						
Shear loads: concrete pryout failure								
k_8	Pryout factor: [mm]	1,0		1,0		1,0	1,0	2,0
γ_{ins}	Installation safety factor: [--]	1,0						
Shear loads: concrete edge failure								
l_f	Effective length of fastener under shear loads: [mm]	26,0	43,0	37,5	50,5	41,5	58,5	67,0
d_{nom}	Outside fastener diameter: [mm]	6		8		10		
γ_{inst}	Installation safety factor: [--]	1,0						

¹⁾ In absence of other national regulations

Characteristic values of resistance to shear loads according to design method A		Performances					
		12		14		18	
h_{nom}	Nominal embedment depth: [mm]	75	105	75	115	90	140
Shear loads: steel failure without lever arm							
$V_{Rk,s}$	Characteristic resistance: [kN]	37,24		52,72		80,78	
k_7	Ductility factor	0,8					
γ_{Ms}	Partial safety factor ¹⁾ : [--]	1,5					
Shear loads: steel failure with lever arm							
$M^0_{Rk,s}$	Characteristic bending moment: [Nm]	126,5		218,3		421,2	
γ_{Ms}	Partial safety factor ¹⁾ : [-]	1,5					
Shear loads: concrete pry-out failure							
k_8	Pry-out factor: [mm]	1,0	2,0	1,0	2,0	2,0	
γ_{ins}	Installation safety factor: [--]	1,0					
Shear loads: concrete edge failure							
l_f	Effective length of fastener under shear loads: [mm]	58,0	83,5	58,0	92,0	69,5	112,0
d_{nom}	Outside fastener diameter: [mm]	12		14		18	
γ_{inst}	Installation safety factor: [--]	1,0					

¹⁾ In absence of other national regulations

THE screw anchor

Performances

Characteristic values for shear loads

Annex C4

Table C4: Displacements under service loads

Displacements under loads			Performances						
			6		8		10		
h_{nom}	Nominal embedment depth:	[mm]	35	55	50	65	55	75	85
Displacements under tension loads in uncracked concrete									
N	Service tension load:	[kN]	1,98	6,61	4,48	8,41	6,26	10,48	12,85
δ_{N0}	Short term displacement:	[mm]	0,03	0,05	0,04	0,05	0,06	0,09	0,10
$\delta_{N\infty}$	Long term displacement:	[mm]	0,25	0,30	0,26	0,35	0,30	0,42	0,65
Displacements under tension loads in cracked concrete									
N	Service tension load:	[kN]	1,81	4,62	3,14	5,88	4,38	7,34	8,99
δ_{N0}	Short term displacement:	[mm]	0,08	0,10	0,09	0,20	0,11	0,35	0,44
$\delta_{N\infty}$	Long term displacement:	[mm]	0,77	0,98	0,84	1,21	0,96	1,11	1,34
Displacements under shear loads in uncracked concrete									
V	Service shear load:	[kN]	3,11	3,58	5,04	5,04	6,26	6,55	7,83
δ_{V0}	Short term displacement:	[mm]	1,01	1,27	0,50	0,50	0,70	0,81	0,92
$\delta_{V\infty}$	Long term displacement:	[mm]	1,51	1,90	0,75	0,75	1,05	1,21	1,38
Displacements under shear loads in cracked concrete									
V	Service shear load:	[kN]	2,17	3,58	3,77	5,04	4,38	6,55	7,83
δ_{V0}	Short term displacement:	[mm]	0,88	1,27	0,43	0,50	0,60	0,81	0,92
$\delta_{V\infty}$	Long term displacement:	[mm]	1,32	1,90	0,64	0,75	0,90	1,21	1,38

Displacements under loads			Performances					
			12		14		18	
h_{nom}	Nominal embedment depth:	[mm]	75	105	75	115	90	140
Displacements under tension loads in uncracked concrete								
N	Service tension load:	[kN]	10,35	17,87	10,35	20,67	13,57	27,77
δ_{N0}	Short term displacement:	[mm]	0,10	0,11	0,12	0,15	0,17	0,23
$\delta_{N\infty}$	Long term displacement:	[mm]	0,68	0,68	0,46	0,70	0,50	0,71
Displacements under tension loads in cracked concrete								
N	Service tension load:	[kN]	7,24	12,51	7,24	14,47	9,50	19,44
δ_{N0}	Short term displacement:	[mm]	0,24	0,46	0,34	0,51	0,41	0,55
$\delta_{N\infty}$	Long term displacement:	[mm]	1,19	1,22	1,19	1,15	1,22	1,44
Displacements under shear loads in uncracked concrete								
V	Service shear load:	[kN]	7,83	10,64	10,35	15,06	15,06	23,08
δ_{V0}	Short term displacement:	[mm]	0,76	1,15	0,85	1,26	0,75	1,43
$\delta_{V\infty}$	Long term displacement:	[mm]	1,14	1,72	1,27	1,89	1,12	2,14
Displacements under shear loads in cracked concrete								
V	Service shear load:	[kN]	7,24	10,64	7,24	15,06	15,06	23,08
δ_{V0}	Short term displacement:	[mm]	0,72	1,15	0,80	1,26	0,75	1,43
$\delta_{V\infty}$	Long term displacement:	[mm]	1,08	1,72	1,20	1,89	1,12	2,14

THE screw anchor

Performances

Displacements under tension and shear loads

Annex C5

English translation prepared by IETcc

Table C5: Characteristic values for resistance to fire

Characteristic values for resistance to fire				Performances						
				6		8		10		
h_{nom}	Nominal embedment depth:	[mm]		35	55	50	65	55	75	85
Steel failure										
$N_{Rk,s,fi}$	Characteristic tension resistance:	R30	[kN]	0,26		0,45		1,07		
		R60	[kN]	0,23		0,41		0,93		
		R90	[kN]	0,18		0,32		0,71		
		R120	[kN]	0,13		0,23		0,57		
$V_{Rk,s,fi}$	Characteristic shear resistance:	R30	[kN]	0,26		0,45		1,07		
		R60	[kN]	0,23		0,41		0,93		
		R90	[kN]	0,18		0,32		0,71		
		R120	[kN]	0,13		0,23		0,57		
$M^0_{Rk,s,fi}$	Characteristic bending resistance:	R30	[kN]	0,22		0,52		1,52		
		R60	[kN]	0,20		0,46		1,32		
		R90	[kN]	0,16		0,36		1,02		
		R120	[kN]	0,11		0,26		0,81		
Pull out failure										
$N_{Rk,p,fi}$	Characteristic resistance:	R30 - R90	[kN]	1,25		2)				
		R120	[kN]	1,00						
Concrete cone failure ¹⁾										
$N_{Rk,p,fi}$	Characteristic resistance:	R30 - R90	[kN]	0,59	2,09	1,48	3,12	1,91	4,51	6,33
		R120	[kN]	0,47	1,67	1,19	2,50	1,53	3,61	5,06
$s_{cr,N,fi}$	Critical spacing:	R30 - R120	[mm]	4 x h_{ef}						
$s_{min,fi}$	Minimum spacing:	R30 - R120	[mm]	35		35		50		
$c_{cr,N,fi}$	Critical edge distance:	R30 - R120	[mm]	2 x h_{ef}						
$c_{min,fi}$	Minimum edge distance:	R30 - R120	[mm]	$c_{min} = 2 \times h_{ef}$; if fire attack comes from more than one side, the edge distance of the anchor has to be ≥ 300 mm						
Concrete pry out failure										
k_8	Pry-out factor:	R30 - R120	[mm]	1,0		1,0		1,0		2,0

¹⁾ As a rule, splitting failure can be neglected since cracked concrete and reinforcement is assumed.

²⁾ Pull out failure is not decisive

In absence of other national regulations the partial safety factor for resistance under fire exposure $\gamma_{m,fi} = 1,0$ is recommended

THE screw anchor

Performances

Characteristic values for resistance to fire

Annex C6

Table C6: Characteristic values for resistance to fire (cont)

Characteristic values for resistance to fire				Performances					
				12		14		18	
h_{nom}	Nominal embedment depth:	[mm]		75	105	75	115	90	140
Steel failure									
$N_{Rk,s,fi}$	Characteristic tension resistance:	R30	[kN]	2,01		2,99		4,73	
		R60	[kN]	1,51		2,24		3,56	
		R90	[kN]	1,31		1,94		3,07	
		R120	[kN]	1,01		1,50		2,37	
$V_{Rk,s,fi}$	Characteristic shear resistance:	R30	[kN]	2,01		2,99		4,74	
		R60	[kN]	1,51		2,24		3,56	
		R90	[kN]	1,31		1,94		3,08	
		R120	[kN]	1,01		1,50		2,37	
$M^0_{Rk,s,fi}$	Characteristic bending resistance:	R30	[kN]	3,42		6,19		12,37	
		R60	[kN]	2,56		4,64		9,28	
		R90	[kN]	2,22		4,02		8,04	
		R120	[kN]	1,71		3,10		6,18	
Pull out failure									
$N_{Rk,p,fi}$	Characteristic resistance:	R30 to R120	[kN]	2)	2)	2)	2)	2)	2)
Concrete cone failure ¹⁾									
$N_{Rk,p,fi}$	Characteristic resistance:	R30 - R90	[kN]	4,41	10,97	4,41	13,98	6,93	22,86
		R120	[kN]	3,53	8,78	3,53	11,18	5,55	18,29
$s_{cr,N,fi}$	Critical spacing:	R30 - R120	[mm]	4 x h_{ef}					
$s_{min,fi}$	Minimum spacing:	R30 - R120	[mm]	75		80		90	
$c_{cr,N,fi}$	Critical edge distance:	R30 - R120	[mm]	2 x h_{ef}					
$c_{min,fi}$	Minimum edge distance:	R30 - R120	[mm]	$c_{min} = 2 \times h_{ef}$; if fire attack comes from more than one side, the edge distance of the anchor has to be ≥ 300 mm					
Concrete pry out failure									
k_8	Pry-out factor:	R30 - R120	[mm]	1,0	2,0	1,0	2,0	2,0	2,0

¹⁾ As a rule, splitting failure can be neglected since cracked concrete and reinforcement is assumed.

²⁾ Pull out failure is not decisive

In absence of other national regulations the partial safety factor for resistance under fire exposure $\gamma_{m,fi} = 1,0$ is recommended

THE screw anchor	Annex C7
Performances	
Characteristic values for resistance to fire	