

Features and Benefits

Version 07/06/2018

- High bond strength with High load resistance
- Used with all grades of threaded rod and rebar in accordance with TR029
- Used in non-cracked and cracked concrete
- Fast gelling and curing
- Used in dry and wet concrete
- Used in critical or overhead applications
- Used in corrosive environments
- ETA tested based on life of anchor 50 years
- Used for elevated temperatures - temperature ranges I, II and III
- Used for post installed rebar installations under TR029 and TR023
- Low shrinkage enables large diameter installations
- Close edge distance and small spacing
- Manual cleaning up to 20mm diameter and embedment depths of 240mm
- Independently tested and approved



Contents

- PAGE 1 - Features and Benefits
- PAGE 2 - Loads, Edge and Spacings based on Characteristic bond strengths Showing steel failure
- PAGE 3 - Design Resistance of resin used with various stud strengths, material and rebar.
- PAGE 4 - Characteristic and Design load resistances based on characteristic bond strengths for hef 4d (minimum embedment) to 20d
- PAGE 5 - Bond Strength Factors
- PAGE 6 - Characteristic and Design load resistances for REBAR based on characteristic bond strengths for hef 4d (minimum embedment) to 20d
- PAGE 7 - Bond Strength Factors for REBAR
- PAGE 8 - Material properties for threaded rods and rebar
- PAGE 9 - Tension Edge and Spacing reduction factors
- PAGE 9A,B,C,D - Post Installed Rebar Data
- PAGE 10 - Curing Time / Temperature Range
- PAGE 11 - Installation parameters: drilling hole cleaning and installation

Shelf Life and Storage

This product should be stored between +5°C & +25°C.
The Shelf life of the product is 18 months from the manufacture date.

IMPORTANT The information and data given is based on our own experience, research and testing and is believed to be reliable and accurate. However, as we cannot know the varied uses to which its products may be applied, or the methods of application used, no warranty as to the fitness or suitability of its products is given or implied. It is the users responsibility to determine suitability of use. For further information please contact Our Technical Department.

Product Description

Chemfix CH+ is a 2 component high strength 10:1 ratio chemical anchoring resin system. It is designed as a fast curing high strength resin fixing anchor for very high loads and critical and overhead fixings especially in corrosive environments, or damp conditions.

Available in sizes : 150/165/170/280/300ml Foil Bag 10:1, 330/345/350/825ml Side By Side and 380/400/410ml Coaxial Cartridges

Specific Benefits

- European Approved
- High loads possible
- High chemical resistance
- Use with potable water
- Studs and rebar
- Cracked or Non-Cracked
- A+ Rating VOC content
- Styrene Free Low odour
- Fire approved R180
- Suitable underwater

Approvals

- ETA Option 7 ETAG 001 for uncracked concrete with studs and rebar TR029
- ETA Option 1 ETAG 001 for cracked concrete with studs
- ETA for post installed Rebar TR023
- Tested to BS6920 for use with potable water
- Tested according to LEED 2009 EQ c4.1, SCAQMD rule 1168 (2005).

Loads, Edge and Spacings based on Characteristic bond strengths - Showing steel failure

Size (mm)	Characteristic Resistance (kN)		Design Resistance (kN)		Recommended Load (kN)		Characteristic distances (mm)			Min Edge and Spacing (mm)	Nominal Embedment (mm)	Hole Diameter concrete (mm)	Hole Diameter fixture (mm)	Max Torque (Nm)
	Tension	Shear	Tension	Shear	Tension	Shear	Edge	Spacing	Edge					
	N_{rk}	V_{rk}	N_{rd}	V_{rd}	N_{rec}	V_{rec}	$C_{cr,N}$	$S_{cr,N}$	$C_{cr,V}$	C_{min}, S_{min}				
8	19.00		12.70		9.07						60			
	19.00	9.00	12.70	7.20	9.07	5.14	80	160	80	40	80	10	9	10
	19.00		12.70		9.07						160			
10	22.62		15.08		10.77						60			
	30.20	15.00	20.10	12.00	14.36	8.57	100	200	90	50	90	12	12	20
	30.20		20.10		14.36						200			
12	29.82		19.88		14.20						70			
	43.80	21.00	29.20	16.80	20.86	12.00	120	240	110	60	110	14	14	40
	43.80		29.20		20.86						240			
16	43.43		28.95		20.68						80			
	67.86	39.00	45.24	31.20	32.31	22.29	160	320	125	80	125	18	18	80
	81.60		54.40		38.86						320			
20	55.42		36.95		26.39						90			
	104.68	61.00	69.79	48.80	49.85	34.86	200	400	180	100	170	22	22	120
	127.40		84.90		60.64						400			
24	63.33		42.22		30.16						100			
	133.00	88.00	88.67	70.40	63.33	50.29	230	460	220	120	210	28	26	160
	183.60		122.40		87.43						480			
27	70.91		47.27		33.77						110			
	154.72	115.00	103.15	92.00	73.68	65.71	270	540	240	135	240	32	30	180
	238.00		159.10		113.64						540			
30	78.04		52.02		37.16						120			
	182.09	142.50	121.39	114.00	86.71	81.43	280	560	280	150	280	35	32	200
	292.00		194.50		138.93						600			
33	88.95		59.30		42.36						130			
	205.27	173.50	136.85	138.80	97.75	121.43	310	620	310	165	300	37	36	250
	360.00		240.60		171.86						660			
36	108.57		72.38		51.70						150			
	246.10	212.50	164.07	170.00	117.19	121.43	330	660	330	180	340	40	38	300
	425.00		283.33		202.38						720			

= steel failure

Table notes : see back page

Design Resistance used with various stud strengths, material and rebar.

5.8 Grade Steel Studding

Stud Diameter (mm)	Hole Diameter (mm)	Embedment Depth h_{ef} (mm)																				h_{ef} failure (mm)	$F_{d,s}$ design load (kN)	
		60	70	80	90	100	110	120	130	140	160	200	240	280	320	400	480	540	600	660	720			
8	10	12.7																			59	12.7		
10	12	15.1	17.6	20.1																	80	20.1		
12	14		19.9	22.7	25.6	28.4	29.2														103	29.2		
16	18			29.0	32.6	36.2	39.8	43.4	47.1	50.7	54.4										150	54.4		
20	22			32.8	36.9	41.1	45.2	49.3	53.4	57.5	65.7	82.1	84.9								207	84.9		
24	28				42.2	46.5	50.7	54.9	59.1	67.6	84.5	101.3	118.2	122.4							290	122.4		
27	30					47.3	51.6	55.9	60.2	68.8	86.0	103.2	120.3	137.5	159.1						370	159.1		
30	35						52.0	56.4	60.7	69.4	86.7	104.1	121.4	138.8	173.4	194.5					449	194.5		
33	38							59.3	63.9	73.0	91.2	109.5	127.7	146.0	182.5	219.0	240.6					527	240.6	
36	40								67.6	77.2	96.5	115.8	135.1	154.4	193.0	231.6	260.6	283.2					587	283.2
Depth (mm)		60	70	80	90	100	110	120	130	140	160	200	240	280	320	400	480	540	600	660	720			

8.8 Grade Steel Studding

Stud Diameter (mm)	Hole Diameter (mm)	Embedment Depth h_{ef} (mm)																				h_{ef} failure (mm)	$F_{d,s}$ design load (kN)		
		60	70	80	90	100	110	120	130	140	160	200	240	280	320	400	480	540	600	660	720				
8	10	12.9	15.0	17.2	19.3	19.5															91	19.5			
10	12	15.1	17.6	20.1	22.6	25.1	27.6	30.2	30.9												123	30.9			
12	14		19.9	22.7	25.6	28.4	31.2	34.1	36.9	39.8	45.0										158	45.0			
16	18			29.0	32.6	36.2	39.8	43.4	47.1	50.7	57.9	72.4	83.7								231	83.7			
20	22			32.8	36.9	41.1	45.2	49.3	53.4	57.5	65.7	82.1	98.5	114.9	130.7						318	130.7			
24	28				42.2	46.5	50.7	54.9	59.1	67.6	84.5	101.3	118.2	135.1	168.9	188.3					446	188.3			
27	30					47.3	51.6	55.9	60.2	68.8	86.0	103.2	120.3	137.5	171.9	206.3	232.1					570	244.8		
30	35						52.0	56.4	60.7	69.4	86.7	104.1	121.4	138.8	173.4	208.1	234.1	260.2					690	299.2	
33	38							59.3	63.9	73.0	91.2	109.5	127.7	146.0	182.5	219.0	246.4	273.7	301.1				811	370.1	
36	40								67.6	77.2	96.5	115.8	135.1	154.4	193.0	231.6	260.6	289.5	318.5	347.4				903	435.7
Depth (mm)		60	70	80	90	100	110	120	130	140	160	200	240	280	320	400	480	540	600	660	720				

Design Resistance used with various stud strengths, material and rebar.

10.9 Grade Steel Studding

Stud Diameter (mm)	Hole Diameter (mm)	Embedment Depth hef																				hef failure (mm)	F _{d,s} design load (kN)
		60	70	80	90	100	110	120	130	140	160	200	240	280	320	400	480	540	600	660	720		
8	10	12.9	15.0	17.2	19.3	21.4	23.6	25.7	27.2												127	27.2	
10	12	15.1	17.6	20.1	22.6	25.1	27.6	30.2	32.7	35.2	40.2	43.1									171	43.1	
12	14		19.9	22.7	25.6	28.4	31.2	34.1	36.9	39.8	45.4	56.8	62.6								220	62.6	
16	18			29.0	32.6	36.2	39.8	43.4	47.1	50.7	57.9	72.4	86.9	101.3	115.8	116.6					322	116.6	
20	22			32.8	36.9	41.1	45.2	49.3	53.4	57.5	65.7	82.1	98.5	114.9	131.4	164.2					443	182.0	
24	28				42.2	46.5	50.7	54.9	59.1	67.6	84.5	101.3	118.2	135.1	168.9	202.7					621	262.2	
27	30					47.3	51.6	55.9	60.2	68.8	86.0	103.2	120.3	137.5	171.9	206.3	232.1				793	341.0	
30	35						52.0	56.4	60.7	69.4	86.7	104.1	121.4	138.8	173.4	208.1	234.1	260.2			961	416.7	
33	38							59.3	63.9	73.0	91.2	109.5	127.7	146.0	182.5	219.0	246.4	273.7	301.1		1130	515.5	
36	40									67.6	77.2	96.5	115.8	135.1	154.4	193.0	231.6	260.6	289.5	318.5	347.4	1258	606.9
Depth (mm)		60	70	80	90	100	110	120	130	140	160	200	240	280	320	400	480	540	600	660	720		

A4-70 Stainless Steel Studding

Stud Diameter (mm)	Hole Diameter (mm)	Embedment Depth hef																				hef failure (mm)	F _{d,s} design load (kN)
		60	70	80	90	100	110	120	130	140	160	200	240	280	320	400	480	540	600	660	720		
8	10	12.9	13.7																			64	13.7
10	12	15.1	17.6	20.1	21.7																	86	21.7
12	14		19.9	22.7	25.6	28.4	31.2	31.6														111	31.6
16	18			29.0	32.6	36.2	39.8	43.4	47.1	50.7	57.9	58.8										162	58.8
20	22			32.8	36.9	41.1	45.2	49.3	53.4	57.5	65.7	82.1	91.7									223	91.7
24	28				42.2	46.5	50.7	54.9	59.1	67.6	84.5	101.3	118.2	132.1								313	132.1
27	30					47.3	51.6	55.9	60.2	68.8	80.2											187	80.2
30	35						52.0	56.4	60.7	69.4	86.7	98.1										226	98.1
33	38							59.3	63.9	73.0	91.2	109.5	121									266	121.3
36	40									67.6	77.2	96.5	115.8	135.1	143							296	142.8
Depth (mm)		60	70	80	90	100	110	120	130	140	160	200	240	280	320	400	480	540	600	660	720		

*1 = Tensile strength 500N/mm2

Design Resistance used with various stud strengths, material and rebar.

A4-80 Stainless Steel Studding

Stud Diameter (mm)	Hole Diameter (mm)	Embedment Depth h _{ef}																	h _{ef} failure (mm)	F _{d,s} design load (kN)			
		60	70	80	90	100	110	120	130	140	160	200	240	280	320	400	480	540			600	660	720
8	10	12.9	15.0	15.7																	73	15.7	
10	12		17.6	20.1	22.6	24.8															99	24.8	
12	14		19.9	22.7	25.6	28.4	31.2	34.1	36.1												127	36.1	
16	18			29.0	32.6	36.2	39.8	43.4	47.1	50.7	57.9	67.2									186	67.2	
20	22			32.8	36.9	41.1	45.2	49.3	53.4	57.5	65.7	82.1	98.5	104.8							255	104.8	
24	28				42.2	46.5	50.7	54.9	59.1	67.6	84.5	101.3	118.2	132.1							313	132.1	
27	30					47.3	51.6	55.9	60.2	68.8	80.2										187	80.2	
30	35						52.0	56.4	60.7	69.4	86.7	98.1									226	98.1	
33	38							59.3	63.9	73.0	91.2	109.5	121.3								266	121.3	
36	40								67.6	77.2	96.5	115.8	135.1	142.8							296	142.8	
Depth (mm)		60	70	80	90	100	110	120	130	140	160	200	240	280	320	400	480	540	600	660	720		

High bond reinforcing bars F_{yk}=500N/mm²

Rebar Diameter (mm)	Hole Diameter (mm)	Embedment Depth h _{ef}																	h _{ef} failure (mm)	F _{d,s} yield load (kN)			
		60	70	80	90	100	110	120	130	140	160	200	240	280	320	400	500	560			640	720	800
8	10	8.7	10.2	11.7	13.1	14.6	16.0	17.5	19.0	20.4	21.9										150	21.9	
10	12	10.4	12.1	13.8	15.6	17.3	19.0	20.7	22.5	24.2	27.6	34.1									198	34.1	
12	14		13.7	15.7	17.6	19.6	21.6	23.5	25.5	27.4	31.4	39.2	47.1	49.2							251	49.2	
16	20			19.3	21.7	24.1	26.5	29.0	31.4	33.8	38.6	48.3	57.9	67.6	77.2						362	87.4	
20	25				21.0	23.6	26.2	28.9	31.5	34.1	36.7	42.0	52.5	63.0	73.5	84.0	105.0				521	136.6	
25	30					28.3	31.1	33.9	36.8	39.6	45.2	56.6	67.9	79.2	90.5	113.1	141.4				695	196.5	
28	35						33.4	36.4	39.5	42.5	48.6	60.7	72.8	85.0	97.1	121.4	151.8	170.0			882	267.8	
32	40							43.1	46.5	53.1	66.4	79.6	92.9	106.2	132.7	165.9	185.8	212.3			1054	349.7	
36	44								52.3	59.7	74.7	89.6	104.5	119.4	149.3	186.6	209.0	238.9	268.8		1188	443.5	
40	50									66.4	82.9	99.5	116.1	132.7	165.9	207.4	232.3	265.4	298.6	331.8	1317	546.3	
Depth (mm)		60	70	80	90	100	110	120	130	140	160	200	240	280	320	400	500	560	640	720	800		

Characteristic and Design Load resistances based on characteristic bond strengths for hef 4d (minimum embedment) to 20d

Size (mm)	Non Cracked Concrete						Cracked Concrete						Nominal Embedment (mm)			
	Characteristic Resistance (kN)		Design Resistance (kN)		Recommended Load (kN)		Characteristic Resistance (kN)		Design Resistance (kN)		Recommended Load (kN)					
	Tension	Shear	Tension	Shear	Tension	Shear	Tension	Shear	Tension	Shear	Tension	Shear				
	N_{rk}	V_{rk}	N_{rd}	V_{rd}	N_{rec}	V_{rec}	N_{rk}	V_{rk}	N_{rd}	V_{rd}	N_{rec}	V_{rec}				
8	19.30	9.00	12.87	7.20	9.19	5.14	Not Applicable	Not Applicable	Not Applicable	Not Applicable	Not Applicable	Not Applicable	60			
	25.74		17.16		12.26								80			
	51.47		34.31		24.51								160			
10	22.62	15.00	15.08	12.00	10.77	8.57	10.40	15.00	6.94	12.00	4.96	8.57	60			
	33.93		22.62		16.16		15.60		10.40		7.43		90			
	75.40		50.27		35.90		34.68		23.12		16.52		200			
12	29.82	21.00	19.88	16.80	14.20	12.00	13.12	21.00	8.75	16.80	6.24	12.00	70			
	46.86		31.24		22.31		20.62		13.75		9.82		110			
	102.24		68.16		48.69		44.98		29.98		21.42		240			
16	43.43	39.00	28.95	31.20	20.68	22.29	17.37	39.00	11.58	31.20	8.27	22.29	80			
	67.86		45.24		32.31		27.14		18.10		12.93		125			
	173.72		115.81		82.72		69.50		46.33		33.10		320			
20	55.42	61.00	36.95	48.80	26.39	34.86	21.06	61.00	14.04	48.80	10.00	34.86	90			
	104.68		69.79		49.85		39.78		26.52		18.94		170			
	246.30		164.20		117.29		93.60		62.40		44.59		400			
24	63.33	88.00	42.22	70.40	30.16	50.29	Not Applicable	Not Applicable	Not Applicable	Not Applicable	Not Applicable	Not Applicable	100			
	133.00		88.67		63.33								Not Applicable	Not Applicable	Not Applicable	210
	304.01		202.67		144.76								Not Applicable	Not Applicable	Not Applicable	480
27	70.91	115.00	47.27	92.00	33.77	65.71	Not Applicable	Not Applicable	Not Applicable	Not Applicable	Not Applicable	Not Applicable	110			
	154.72		103.15		73.68								Not Applicable	Not Applicable	Not Applicable	240
	348.11		232.08		165.77								Not Applicable	Not Applicable	Not Applicable	540
30	78.04	142.50	52.02	114.00	37.16	81.43	Not Applicable	Not Applicable	Not Applicable	Not Applicable	Not Applicable	Not Applicable	120			
	182.09		121.39		86.71								Not Applicable	Not Applicable	Not Applicable	280
	390.19		260.12		185.80								Not Applicable	Not Applicable	Not Applicable	600
33	88.95	173.50	59.30	138.80	42.36	99.14	Not Applicable	Not Applicable	Not Applicable	Not Applicable	Not Applicable	Not Applicable	130			
	205.27		136.85		97.75								Not Applicable	Not Applicable	Not Applicable	300
	451.60		301.07		215.05								Not Applicable	Not Applicable	Not Applicable	660
36	108.57	212.50	72.38	170.00	51.70	121.43	Not Applicable	Not Applicable	Not Applicable	Not Applicable	Not Applicable	Not Applicable	150			
	246.10		164.07		117.19								Not Applicable	Not Applicable	Not Applicable	340
	521.15		347.44		248.17								Not Applicable	Not Applicable	Not Applicable	720

Table notes : see back page

Bond Strength Factors

Influence of concrete strength on combined pull out and concrete cone resistance

Concrete Strength N/mm ² (Mpa)	C15/20	C20/25	C25/30	C30/37	C35/45	C40/50	C45/55	C50/60
non cracked f_c =	0.94	1.00	1.06	1.12	1.17	1.23	1.26	1.30
cracked f_c =	0.96	1.00	1.03	1.05	1.06	1.07	1.08	1.09

Influence of environmental conditions in non cracked concrete

		M8	M10	M12	M16	M20	M24	M27	M30	M33	M36
Temp I 40°C / 24°C	Dry and Wet	1.00	1.00	1.00	1.00	1.00	1.00	1.00	1.00	1.00	1.00
Temp II 80°C / 50°C	Dry and Wet	0.90	0.88	0.87	0.86	0.85	0.84	0.83	0.82	0.81	0.80

Influence of environmental conditions in cracked concrete

		M8	M10	M12	M16	M20	M24	M27	M30
Temp I 40°C / 24°C	Dry and Wet	n/a	0.46	0.44	0.40	0.38	n/a	n/a	n/a
Temp II 80°C / 50°C	Dry and Wet	n/a	0.45	0.43	0.40	0.38	n/a	n/a	n/a

Table notes : see back page

*Characteristic and Design Load resistances for **REBAR** based on characteristic bond strengths for hef 4d (min embedment) to 20d*

Rebar Ø	Non Cracked Concrete						Cracked Concrete						Nominal Embedment (mm)
	Characteristic Resistance (kN)		Design Resistance (kN)		Recommended Load (kN)		Characteristic Resistance (kN)		Design Resistance (kN)		Recommended Load (kN)		
	Tension	Shear	Tension	Shear	Tension	Shear	Tension	Shear	Tension	Shear	Tension	Shear	
	N _{rk}	V _{rk}	N _{rd}	V _{rd}	N _{rec}	V _{rec}	N _{rk}	V _{rk}	N _{rd}	V _{rd}	N _{rec}	V _{rec}	
8	15.68		8.71		6.22		Not Applicable	Not Applicable	Not Applicable	Not Applicable	Not Applicable	Not Applicable	60
	20.91	13.95	11.62	9.30	8.30	6.64							80
	41.82		23.23		16.60								160
10	18.66		10.37		7.41		Not Applicable	Not Applicable	Not Applicable	Not Applicable	Not Applicable	Not Applicable	60
	27.99	21.45	15.55	14.30	11.11	10.21							90
	62.20		34.56		24.68								200
12	24.70		13.72		9.80		10.56		5.86		4.19		70
	38.82	31.05	21.56	20.70	15.40	14.79	16.59	31.05	9.22	20.70	6.58	14.79	110
	84.69		47.05		33.61		36.19		20.11		14.36		240
14	31.67		17.59		12.57		13.72		7.62		5.45		80
	45.52	42.45	25.29	28.30	18.06	20.21	19.73	42.45	10.96	28.10	7.83	20.07	115
	110.84		61.58		43.98		48.03		26.68		19.06		280
16	34.74		19.30		13.79		15.28		8.49		6.06		80
	54.29	55.50	30.16	37.00	21.54	26.43	23.88	55.50	13.26	37.00	9.47	26.43	125
	138.97		77.21		55.15		61.12		33.96		24.26		320
18	37.55		20.86		14.90		16.51		9.17		6.55		80
	70.40	69.66	39.11	46.44	27.94	33.17	30.96	69.66	17.20	46.44	12.29	33.17	150
	168.97		93.87		67.05		74.31		41.28		29.49		360
20	36.76		20.42		14.59		19.79		11.00		7.85		90
	69.43	86.55	38.57	57.70	27.55	41.21	37.39	86.55	20.77	57.70	14.84	41.21	170
	163.36		90.76		64.83		87.96		48.87		34.91		400
22	44.92		24.96		17.83		24.19		13.44		9.60		100
	85.36	104.01	47.42	69.34	33.87	49.53	45.96	104.01	25.53	69.34	18.24	49.53	190
	197.67		109.82		78.44		106.44		59.13		42.24		440
25	51.05		28.36		20.26		27.49		15.27		10.91		100
	107.21	135.00	59.56	90.00	42.54	64.29	57.73	135.00	32.07	90.00	22.91	64.29	210
	255.26		141.81		101.29		137.45		76.36		54.54		500
28	61.08		33.93		24.24		Not Applicable	Not Applicable	Not Applicable	Not Applicable	Not Applicable	Not Applicable	112
	152.71	168.75	84.84	112.50	60.60	80.36							280
	305.41		169.67		121.20								560
32	77.21		42.89		30.64		Not Applicable	Not Applicable	Not Applicable	Not Applicable	Not Applicable	Not Applicable	128
	193.02	220.95	107.23	147.30	76.60	105.21							320
	386.04		214.47		153.19								640

Table notes : see back page

Bond Strength Factors - REBAR

Influence of concrete strength on combined pull out and concrete cone resistance

Concrete Strength N/mm ² (MPa)	C15/20	C20/25	C25/30	C30/37	C35/45	C40/50	C45/55	C50/60
non cracked f_c =	0.94	1.00	1.06	1.12	1.17	1.23	1.26	1.30
cracked f_c =	0.96	1.00	1.03	1.05	1.06	1.07	1.08	1.09

Influence of environmental conditions in non cracked concrete

		Ø 8	Ø 10	Ø 12	Ø 14	Ø 16	Ø 18	Ø 20	Ø 22	Ø 25	Ø 28	Ø 32
Temp I 40°C / 24°C	Dry and Wet	1.00	1.00	1.00	1.00	1.00	1.00	1.00	1.00	1.00	1.00	1.00
Temp II 80°C / 50°C	Dry and Wet	0.90	0.90	0.88	0.88	0.88	0.86	0.86	0.86	0.86	0.84	0.84

Influence of environmental conditions in cracked concrete

		Ø 8	Ø 10	Ø 12	Ø 14	Ø 16	Ø 18	Ø 20	Ø 22	Ø 25	Ø 28	Ø 32
Temp I 40°C / 24°C	Dry and Wet	n/a	n/a	0.43	0.43	0.43	0.43	0.53	0.53	0.53	n/a	n/a
Temp II 80°C / 50°C	Dry and Wet	n/a	n/a	0.38	0.38	0.38	0.38	0.46	0.46	0.46	n/a	n/a

Table notes : see back page

Material Properties for grades of other threaded rod and rebar

Stud Diameter (mm)	Stud Grade 8.8		Stud Grade 10.9		Stud Grade A4-70		Stud Grade A4-80	
	$N_{rk,s}$ (kN)	$N_{rd,s}$ (kN)	$N_{rk,s}$ (kN)	$N_{rd,s}$ (kN)	$N_{rk,s}$ (kN)	$N_{rd,s}$ (kN)	$N_{rk,s}$ (kN)	$N_{rd,s}$ (kN)
M8	29.2	19.5	38.1	27.2	25.6	13.7	29.2	15.6
M10	46.4	30.9	60.3	43.1	40.6	21.7	46.4	24.8
M12	67.4	44.9	87.7	62.6	59.0	31.6	67.4	36.0
M16	125.6	83.7	163.0	116.4	109.9	58.8	125.7	67.2
M20	196.1	130.7	255.0	182.1	171.5	91.7	196.0	104.8
M24	282.5	188.3	367.0	262.1	247.1	132.1	293.0	132.1
M27	367.0	244.7	477.4	341.0	229.4	80.2	229.4	80.2
M30	448.8	299.2	583.0	416.4	280.6	98.1	280.6	98.1
M36	653.6	435.7	849.7	606.9	408.4	142.8	408.4	142.8

*1

*1

*1

*1 = Tensile strength 500N/mm2

Stud Diameter (mm)	Stud Grade 8.8		Stud Grade 10.9		Stud Grade A4-70		Stud Grade A4-80	
	$V_{rk,s}$ (kN)	$V_{rd,s}$ (kN)	$V_{rk,s}$ (kN)	$V_{rd,s}$ (kN)	$V_{rk,s}$ (kN)	$V_{rd,s}$ (kN)	$V_{rk,s}$ (kN)	$V_{rd,s}$ (kN)
M8	14.6	11.7	19.0	15.2	12.8	8.2	14.6	9.4
M10	23.2	18.6	30.2	24.1	20.3	13.0	23.2	14.9
M12	33.7	27.0	43.8	35.1	29.5	18.9	33.7	21.6
M16	62.8	50.2	81.6	65.3	55.0	35.2	62.8	40.3
M20	98.0	78.4	127.4	101.9	85.8	55.0	98.0	62.8
M24	141.2	113.0	183.6	146.8	123.6	79.2	141.2	90.5
M27	183.5	146.8	238.7	191.0	114.7	48.4	114.7	48.4
M30	224.4	179.5	291.5	215.9	140.3	59.2	140.3	59.2
M36	326.8	261.4	424.8	283.2	204.2	86.2	204.2	86.2

Rebar Diameter (mm)	Rebar BSt 500 to DIN 488		Rebar BSt 500 to DIN 488	
	$N_{rk,s}$ (kN)	$N_{rd,s}$ (kN)	$V_{rk,s}$ (kN)	$V_{rd,s}$ (kN)
8	28.0	20.0	14.0	9.3
10	43.0	30.7	21.5	14.3
12	62.0	44.3	31.0	20.7
14	84.4	67.0	42.5	28.3
16	111.0	79.3	55.5	37.0
18	139.5	100.0	70.0	46.7
20	173.0	123.6	86.5	57.7
22	208.3	149.3	104.5	69.7
25	270.0	192.9	135.0	90.0
28	339.0	242.1	169.0	112.7
32	442	315.7	221	147.3
36	563.2	443.5	281.6	187.7
40	693.8	546.3	346.9	231.3

More notes : see back page

Effect of Anchor Spacing - Tension

Anchor Spacing (mm)	Stud / Rebar Diameter										
	8	10	12	16	20	24	27	30	33	36	40
40	0.64										
50	0.67	0.63									
60	0.70	0.65	0.63								
70	0.73	0.67	0.64								
80	0.76	0.69	0.66	0.63							
90	0.79	0.72	0.68	0.64							
100	0.82	0.74	0.70	0.65	0.63						
120	0.87	0.79	0.74	0.68	0.65	0.63					
150	0.96	0.86	0.80	0.73	0.68	0.65	0.64	0.63			
160	1.00	0.88	0.82	0.74	0.70	0.66	0.65	0.63	0.62		0.63
180		0.93	0.86	0.77	0.72	0.68	0.65	0.65	0.64	0.64	0.64
200		1.00	0.90	0.80	0.74	0.69	0.67	0.66	0.65	0.65	0.65
225			0.95	0.84	0.77	0.72	0.69	0.68	0.67	0.67	0.66
240			1.00	0.86	0.79	0.73	0.71	0.69	0.69	0.68	0.67
250				0.87	0.80	0.74	0.72	0.70	0.70	0.68	0.68
275				0.91	0.83	0.76	0.74	0.72	0.72	0.70	0.69
280				0.92	0.84	0.77	0.75	0.73	0.72	0.70	0.69
300				0.95	0.86	0.79	0.76	0.74	0.74	0.72	0.71
320				1.00	0.88	0.81	0.78	0.76	0.75	0.73	0.72
350					0.92	0.83	0.81	0.78	0.78	0.75	0.73
400					1.00	0.88	0.86	0.82	0.82	0.78	0.76
440						0.92	0.89	0.85	0.85	0.81	0.79
460						1.00	0.91	0.87	0.87	0.82	0.80
500							0.95	0.90	0.90	0.85	0.82
540								1.00	0.93	0.93	0.88
560									1.00	0.95	0.89
620										1.00	0.93
660											1.00
720											1.00

Effect of Edge Distance - Tension

Edge Distance (mm)	Stud / Rebar Diameter										
	8	10	12	16	20	24	27	30	33	36	40
40	0.64										
50	0.73	0.63									
60	0.82	0.70	0.63								
70	0.90	0.77	0.68								
80	1.00	0.84	0.74	0.63							
90		0.91	0.80	0.67							
100		1.00	0.86	0.71	0.63						
110			0.92	0.76	0.66						
120			1.00	0.80	0.70	0.64					
140				0.89	0.77	0.67	0.63	0.63			
160				1.00	0.84	0.72	0.70	0.65	0.62		
180					0.91	0.78	0.75	0.66	0.70	0.67	0.68
200					1.00	0.84	0.81	0.76	0.76	0.78	0.71
220						0.89	0.86	0.81	0.81	0.82	0.75
240						1.00	0.92	0.86	0.86	0.87	0.78
270							1.00	0.94	0.94	0.93	0.83
280								1.00	0.97	0.96	0.85
310									1.00	0.98	0.90
330										1.00	0.93
360											1.00

Effect of Edge Distance - Shear

Edge Distance (mm)	Stud / Rebar Diameter										
	8	10	12	16	20	24	27	30	33	36	40
40	0.25										
50	0.44	0.30									
60	0.63	0.48	0.30								
70	0.81	0.65	0.44								
80	1.00	0.83	0.58	0.40							
90		1.00	0.72	0.53							
100			0.86	0.67	0.35						
110			1.00	0.80	0.44						
125				1.00	0.58	0.35					
140					0.72	0.46	0.44	0.30			
160					0.91	0.62	0.57	0.35	0.34		
180					1.00	0.77	0.69	0.46	0.41	0.33	
200						0.92	0.82	0.57	0.50	0.42	0.32
220							1.00	0.94	0.68	0.59	0.53
240								1.00	0.78	0.68	0.59
280									1.00	0.86	0.78
310										1.00	0.91
330											1.00
360											1.00

Post installed rebar connections

Minimum anchorage length ¹⁾ and lap splice length for C20/25 and maximum installation length (l_{max})

Rebar		$l_{b,min}$ (mm)	$l_{o,min}$ (mm)	$l_{max,min}$ (mm)
$\varnothing d_s$ (mm)	$f_{y,k}$ (N/mm ²)			
8	500	163	200	1000
10	500	204	204	1000
12	500	170	200	1200
14	500	198	210	1400
16	500	227	240	1600

N/mm² =
MPa

1) According to EN 1992-1-1:2004 $l_{b,min}$ (8.6) and $l_{o,min}$ (8.11) for good bond conditions and $a_{\delta} = 1,0$ with maximum yield stress for rebar B500 B and $\gamma_M = 1,15$

Design values of the ultimate bond resistance f_{bd} ¹⁾ in N/mm² for all drilling methods for good conditions

Rebar \varnothing	Concrete Class								
	C12/15	C16/20	C20/25	C25/30	C30/37	C35/45	C40/50	C45/60	C50/60
8 mm	1.6	1.6	1.6	1.6	1.6	1.6	1.6	1.6	1.6
10 mm	1.6	1.6	1.6	1.6	1.6	1.6	1.6	1.6	1.6
12 mm	1.6	2	2.3	2.3	2.3	2.3	2.3	2.3	2.3
14 mm	1.6	2	2.3	2.7	3	3.4	3.4	3.4	3.4
16 mm	1.6	2	2.3	2.7	3	3.4	3.7	4	4.3

1) Tabulated values for f_{bd} are valid for good bond condition according to EN1992-1-1:2004. For all other bond conditions multiply the values for f_{bd} by 0.7.

Post installed rebar connections

Values for pre-calculation of anchoring

Rebar - \emptyset ds	$\alpha_1=\alpha_2=\alpha_3=\alpha_4=\alpha_5=1.0$			α_2 or $\alpha_5=0.7$; $\alpha_1=\alpha_3=\alpha_4=1.0$		
	Anchorage length l_{bd}	Design value N_{rd}	Mortar volume	Anchorage length l_{bd}	Design value N_{rd}	Mortar volume
(mm)	(mm)	(kN)	(ml)	(mm)	(kN)	(ml)
8	163*	6.55	12	163*	9.42	12
	180	7.23	14	175	10.11	13
	250	10.05	19	190	10.98	14
	378	15.19	28	265	15.31	20
10	204*	10.25	18	204*	14.73	18
	220	11.05	20	220	15.89	20
	310	15.57	28	240	17.33	22
	390	19.59	35	280	20.22	25
	473	23.76	43	331	23.90	30
12	170*	14.74	18	170*	21.06	18
	270	23.41	29	230	28.49	24
	370	32.08	39	280	34.68	30
	470	40.75	50	340	42.12	36
	567	49.16	60	397	49.18	42
14	198*	20.03	24	198*	28.61	24
	310	31.36	37	260	37.57	31
	430	43.5	52	330	47.69	40
	550	55.64	66	400	57.81	48
	662	66.97	80	463	66.91	56
16	227*	26.24	31	227*	37.49	31
	360	41.62	49	300	49.55	41
	490	56.65	67	380	62.76	52
	620	71.68	84	450	74.32	61
	756	87.4	103	529	87.37	72

Example For:

C20/25;
 good bond condition;
 Rebar Yield Strength
 500 N/mm² (500 MPa)

* Minimum anchorage length. The design value is valid for "good bond conditions" according to EN 1992-1-1.

All other condition: multiply value by 0.7. Mortar volume based on equation: $V = 1.2 \cdot (d_o^2 - d_d^2) \cdot \pi \cdot l_b / 4$

Post installed rebar connections

Values for pre-calculation of overlap joints

Rebar - Ø ds	$\alpha_1=\alpha_2=\alpha_3=\alpha_4=\alpha_5=1.0$			α_2 or $\alpha_5=0.7$; $\alpha_1=\alpha_3=\alpha_4=1.0$		
	Anchorage length l_{bd}	Design value N_{rd}	Mortar volume	Anchorage length l_{bd}	Design value N_{rd}	Mortar volume
(mm)	(mm)	(kN)	(ml)	(mm)	(kN)	(ml)
8	200	8.04	15	200	11.56	15
	240	9.65	18	220	12.71	17
	290	11.66	22	230	13.29	17
	378	15.19	29	265	15.31	20
10	204	10.25	18	204	14.73	18
	270	13.56	24	230	16.61	21
	340	17.08	31	270	19.50	24
	400	20.10	36	300	21.67	27
	473	23.76	43	331	23.90	30
12	200	17.33	21	200	24.77	21
	290	25.13	31	250	30.97	26
	380	32.93	40	300	37.16	32
	480	41.60	51	350	43.35	37
	567	49.14	60	397	49.18	42
14	210	21.24	25	210	30.35	25
	320	32.37	39	270	39.02	33
	440	44.51	53	340	49.13	41
	550	55.64	66	400	57.81	48
	662	66.97	80	463	66.91	56
16	240	27.75	33	240	39.64	33
	370	42.78	50	310	51.2	42
	500	57.81	68	380	62.76	52
	630	72.83	86	460	75.97	62
	756	87.4	103	529	87.37	72

Example For:

C20/25;
 good bond condition;
 Rebar Yield Strength
 500 N/mm² (500 MPa)

* Minimum anchorage length. The design value is valid for "good bond conditions" according to EN 1992-1-1.

All other condition: multiply value by 0.7. Mortar volume based on equation: $V = 1.2 \cdot (d_o^2 - d_d^2) \cdot \pi \cdot l_b / 4$

Post installed rebar schematics

Application examples of post-installed rebar

Figure 1: Overlap joints in slabs and beams.

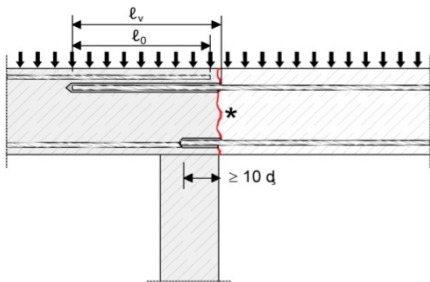

Figure 2: Overlap joint in foundation of a column or wall where the rebars are stressed in tension.

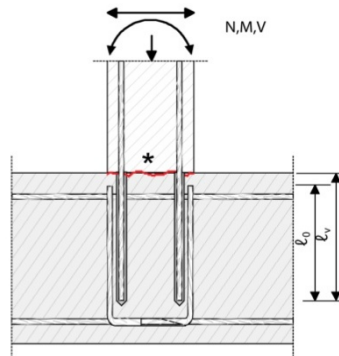

Figure 3: End anchoring of slabs or beams, designed as simply supported.

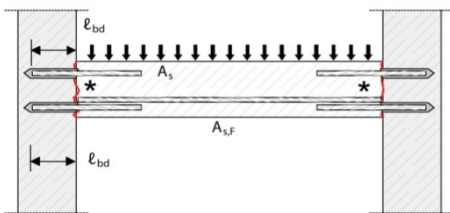

Figure 4: Rebar connection of components stressed primarily in compression. The rebar are stressed in compression.

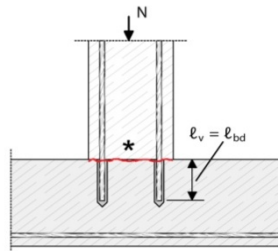
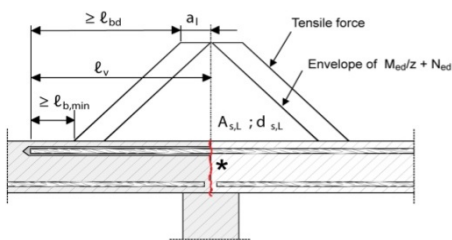

Figure 5: Anchoring of reinforcement to cover the line of acting tensile force.



Note to figure 1 to 5 :

In the figures no transverse reinforcement is plotted, the transverse reinforcement as required by EC 2 shall be present. The shear transfer between old and new concrete shall be designed according to EC2. Description of the bonded-in rebars and overlap joints see Annex 4 and 5.

*** Roughened joint**

Minimum Curing Time

Concrete Temperature	Gel - Working Time	Minimum curing time in dry concrete	Minimum curing time in wet concrete
- 10°C *	50 min	240 min	x2
-5°C *	40 min	180 min	x2
5°C	20 min	90 min	x2
15°C	9 min	60 min	x2
25°C	5 min	30 min	x2
35°C	3 min	20 min	x2

* Resin temperature must be at least 20°C

- Full cure 24 hours

- All specifications based on supplied mixer

Temperature Ranges

Temperature Range	Concrete Service Temperature	Maximum Long Term Concrete Temp	Maximum Short Term Concrete Temp
Range I	-40°C to +40°C	+24°C	+40°C
Range II	-40°C to +80°C	+50°C	+80°C

Service temperature range: Range of ambient temperatures after installation and during the lifetime of the anchor.

Short term temperature: Temperatures within the service temperature range which vary over short intervals, e.g. day/night cycles and freeze/thaw cycles.

Long term temperature: Temperature, within the service temperature range, which will be approximately constant over significant periods of time.

Long term temperatures will include constant or near constant temperatures, such as those experienced in cold stores or next to heating installations.

Physical Properties

	N/mm ² (MPa)	Test Method
Compressive Strength	73.0	EN ISO 604 / ASTM 695
Flexural Strength	25.0	EN ISO 178 / ASTM 790
Flexural Modulus	3850.0	EN ISO 178 / ASTM 790
Tensile Strength	14.6	EN ISO 527 / ASTM 638
E Modulus	8029.7	EN ISO 527 / ASTM 638
VOC Content	A+ Rating	-

Installation parameters: drilling hole cleaning and installation

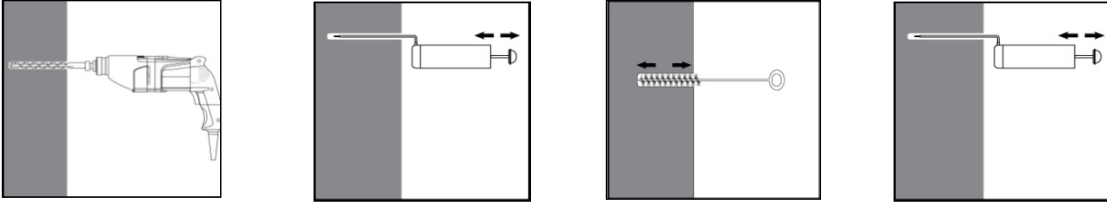

Drill hole in the substrate to the required embedment depth using the appropriately sized carbide drill bit. Bore hole cleaning Just before setting an anchor, the bore hole must be free of dust and debris. The manual pump shall be used for blowing out bore holes up to diameters $d_o \leq 24\text{mm}$ and embedment depths up to $h_{ef} \leq 10d$. Blow out at least 4 times from the back of the bore hole, using an extension if needed. Brush 4 times with the specified brush size (see Table 6) by inserting the steel brush to the back of the hole (if needed with an extension) in a twisting motion and removing it. Blow out again with manual pump at least 4 times.

Compressed air cleaning (CAC) for all bore hole diameters d_o and all bore hole depths

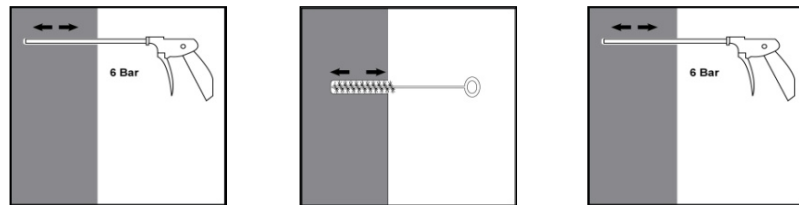

Blow 2 times from the back of the hole (if needed with a nozzle extension) over the whole length with oil-free compressed air (min. 6 bar at $6\text{ m}^3/\text{h}$). Brush 2 times with the specified brush size (see Table 6) by inserting the steel brush to the back of the hole (if needed with an extension) in a twisting motion and removing it.
X 2 Blow out again with compressed air at least 2 times.

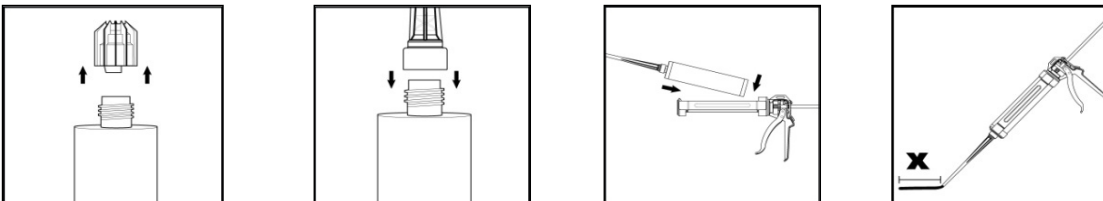

Remove the threaded cap from the cartridge. Tightly attach the mixing nozzle. Do not modify the mixer in any way. Made sure the mixing element is inside the mixer. Use only the supplied mixer. Insert the cartridge into the dispenser gun. Discard the initial trigger pulls of adhesive. Discard the first 12ml of resin. Please note that after every subsequent mixer change, an initial 12ml of resin should be extruded to waste to continue with even mixing.

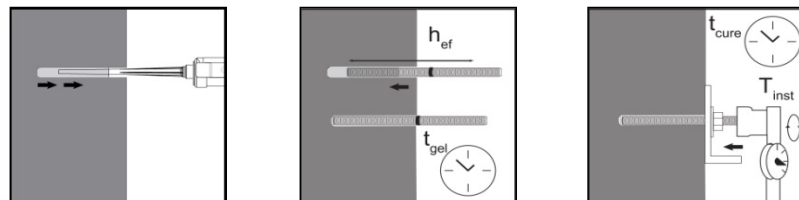

Inject the adhesive starting at the back of the hole, slowly withdrawing the mixer with each trigger pull. Fill holes approximately 2/3 full, to ensure that the annular gap between the anchor and the concrete is completely filled with adhesive along the embedment depth. Before use, verify that the threaded rod is dry and free of contaminants. Install the threaded rod to the required embedment depth during the open gel time t_{gel} has elapsed. The working time t_{gel} is given in Table 7. The anchor can be loaded after the required curing time t_{cure} (see Table 7). The applied torque shall not exceed the values T_{max} given in Table 1.

Notes

PAGE 2 :

Typical characteristic and design resistance performance with 5.8 grade studding and associated installation data

All data is based on correct installation - see instructions

No influence of edge and spacing

Minimum base material thickness hef +30mm >100mm for M8 to M12 and for M16 to M30 hef +2 d

he_f range minimum or 4d whichever is greatest to 20d

Concrete strength C20/25 - f_c cube = 25N/mm² (25MPa)

5.8 grade stud

Temperature range I maximum long term / short term temperature +24/40°C

PAGE 3 :

Design Resistance with various stud strengths, material and rebar.

Note 1 for stainless steel tensile strength is 500N/mm² (500MPa)

Note 2 for stainless steel tensile strength is 700N/mm² (500MPa)

Data shown below the minimum embedment depth is for reference only. Please refer to manufacturer for advice.

PAGE 4 and 6 :

Characteristic and Design Load resistances based on characteristic bond strengths for hef 4d (minimum embedment) to 20d

All data is based on correct installation - see instructions

No influence of edge and spacing

Minimum base material thickness hef +30mm >100mm for M8 to M12 and for M16 to M30 hef +2 d

he_f range minimum or 4d whichever is greatest to 20d

Concrete strength C20/25 - f_c cube = 25N/mm² (25MPa)

Temperature range i maximum long term / short term temperature +24/40°C

PAGE 5 & 7 :

Bond Strength Factors

Select concrete strength and environmental condition and apply to bond strength table on page 4

PAGE 8 :

Material Properties for grades of other threaded rod and rebar

All grades shown for information

M30 studding is 8.8 grade instead of 5.8 grade. >M27 for A4-70 tensile strength of 500N/mm², instead of 700N/mm²

M30 for A4-70 tensile strength of 500N/mm² (500MPa), instead of 700N/mm² (700MPa)

Safety factor is 1.5 tension and 1.25 shear for all carbon steel

Safety factor is 1.87 for stainless steel, up to M24, M27 to M36 is 2.86

Safety factor is 1.56 for stainless steel in shear, up to M24, M27 to M36 is 2.37

Safety factor is 1.4 tension and 1.5 shear for BSt 500 rebar

Partial Safety Factors for pages 2,3,4,5,6,7 :

1.5 for all sizes studs

1.8 for all sizes rebar